

AUDIOCENTER

Dynamic Audio Solutions

PRO Series

**PROFESSIONAL POWER
AMPLIFIERS**

OWNER'S MANUAL



Revision A3-2014-05

www.ac-pro.net

info@ac-pro.net

Important Precautions



This symbol is used to alert the operator to follow important operating and precautions detailed in documentation.



This symbol is used to warn operators that uninsulated "dangerous voltages" are present within the equipment enclosure that may pose a risk of electric shock.

1. Save the carton and packing material even if the equipment has arrived in good condition. Should you ever need to ship the unit, use only the original factory packing.
2. Read all documentation before operating your equipment. Retain all documentation for future reference.
3. Follow all instructions printed on unit chassis for proper operation.
4. Do not spill water or other liquids into or on the unit, or operate the unit while standing in liquid.
5. Make sure power outlets conform to the power requirements listed on the back of the unit.
6. Do not use the unit if the electrical power cord is frayed or broken. The power supply cords should be routed so that they are not likely to be walked on or pinched by items placed upon or against them, paying particular attention to cords and plugs, convenience receptacles, and the point where they exit from the appliance.
7. Always operate the unit with the AC ground wire connected to the electrical system ground. Precautions should be taken so that the means of grounding of a piece of equipment is not defeated.
8. Mains voltage must be correct and same as that printed on the rear of the unit. Damage caused by connection to improper AC voltage is not covered by any warranty.
9. Have gain controls on amplifiers turned down during power-up to prevent speaker damage if there are high signal levels at the inputs.
10. Power down and disconnect units from mains voltage before making connections.

11. Never hold a power switch in the "ON" position if it won't stay there itself!
12. Do not use the unit near stoves, heat registers, radiators, or other heat producing devices.

13. Do not block fan intake or exhaust ports. Do not operate equipment on a surface or in an environment which may impede the normal flow of air around the unit, such as a bed, rug, weather sheet, carpet, or completely enclosed rack. If the unit is used in an extremely dusty or smoky environment, the unit should be periodically "blown free" of foreign matter.

14. Do not remove the cover. Removing the cover will expose you to potentially dangerous voltages. There are no user serviceable parts inside.

15. Connecting amplifier outputs to oscilloscopes or other test equipment while the amplifier is in bridged mode may damage both the amplifier and test equipment!

16. Do not drive the inputs with a signal level greater than that required to drive equipment to full output.

17. Do not connect the inputs / outputs of amplifiers or consoles to any other voltage source, such as a battery, mains source, or power supply, regardless of whether the amplifier or console is turned on or off.

18. Do not run the output of any amplifier channel back into another channel's input. Do not parallel- or series-connect an amplifier output with any other amplifier output. **Audiotronics** is not responsible for damage to loudspeakers for any reason.

19. Do not ground any red ("hot") terminal. Never connect a "hot" (red) output to ground or to another "hot" (red) output!

20. Non-use periods. The power cord of equipment should be unplugged from the outlet when left unused for a long period of time.

21. Service Information. Equipment should be serviced by qualified service personnel when:

- A. The power supply cord or the plug has been damaged;
 - B. Objects have fallen, or liquid has been spilled into the equipment;
 - C. The equipment has been exposed to rain;
 - D. The equipment does not appear to operate normally, or exhibits a marked change in performance;
 - E. The equipment has been dropped, or the enclosure damaged.
22. To obtain service, contact your nearest **Audiotronics** Service Centre, Distributor, Dealer.

Table of Contents

	Introduction	3
	Unpacking	3
	Installation and Mounting	3
	Front Panel	4
	Rear Panel	5
	Operation	6
	Connecting Power / Circuit Size Requirements	6
	Cooling Requirements	6
	Connecting Inputs	7
	Connecting Outputs	7
	Mode Selection	8
	Stereo /Parallel/Bridged Mono Mode	9
	Protection Features	10
	User Precautions	11
	Speaker Protection	11
	Recommended Speaker Cabling	11
	Maintenance	12
	User Responsibility	12
	Service and Repair	12
Appendix A	Specifications	
Appendix B	PRO Block Diagram	
Appendix C	Wire Gauge Charts	

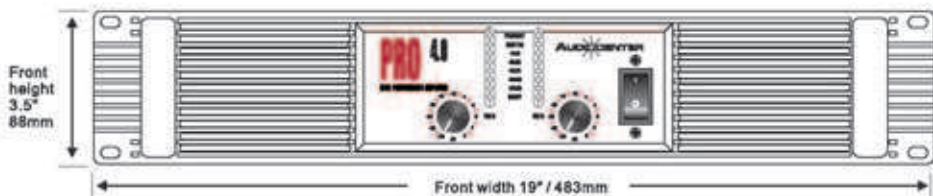
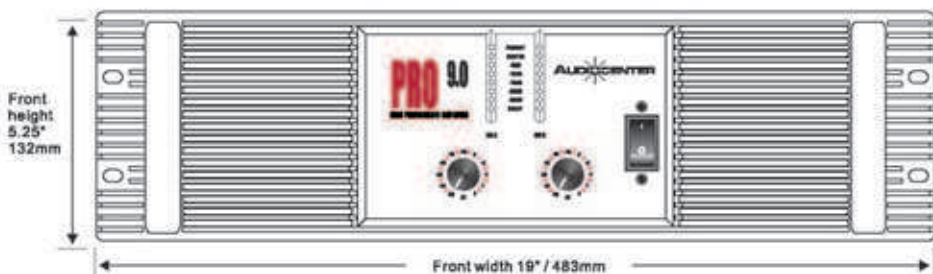
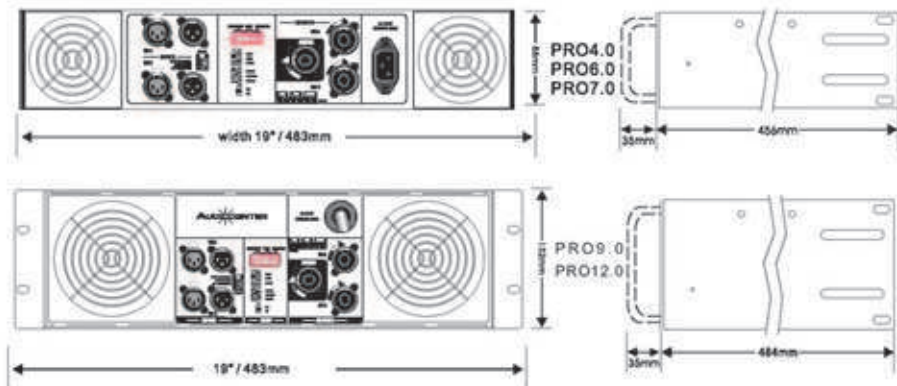
PRO4.0,PRO6.0,PRO7.0 Front View**PRO9.0,PRO12.0 Front View****Rear & Side Views**

Introduction

Congratulations on your purchase of a new PRO Series professional power amplifier, and thank you for your confidence in **AUDIOCENTER** products. You are among the growing number of audio professionals who have made **AUDIOCENTER** one of the world's leading suppliers of professional and commercial/industrial audio systems.

For your safety, please read the Important Precautions section before installing and operating the amplifier. The **AUDIOCENTER** PRO Series is based on an advanced circuit topologist that have made **AUDIOCENTER** amplifiers the choice of touring professionals worldwide. PRO Series amplifiers are designed for high operating efficiency and accurate sonic performance across the full audio bandwidth, even under stressful conditions. In order to maintain strict quality assurance standards, all PRO Series amplifiers are built in **AUDIOCENTER**'s state-of-the-art manufacturing facility. Internal components are the finest available, and key sub assemblies are pre-tested before final assembly. Finally, each amplifier is "burned In" and thoroughly tested (using Audio precision test equipment) before shipping. In addition, all PRO Series amplifiers incorporate **AUDIOCENTER**'s exclusive A-Guard protection features to safeguard both internal circuitry and connected loudspeakers. This proven combination of advanced design, quality structure, and comprehensive circuit protection is your guarantee of fail-safe reliability. You can depend on consistent, stable performance even when your PRO Series amplifier is subjected to punishing extremes in the most demanding fixed or mobile sound reinforcement applications.

Unpacking

Please inspect the amplifier carefully immediately after unpacking. If you find any damage, notify your supplier/dealer immediately. Only the shipper may file a damage claim with the carrier for damage incur Red during shipping. Be sure to save the carton and all packing materials for the carrier's inspection. If your packing materials are in good condition, please save them. If you ever need to ship the unit back to **AUDIOCENTER** or an authorized service centre, you should use only the original factory packing.

Installation and Mounting

PRO4.0,PRO6.0,PRO7.0 are 2-rack-space high and PRO9.0,PRO12.0 are 3-rack-space high.All mount in standard 19-inch racks. Four front-panel mounting holes are provided on each amplifier.Rear mounting ears give additional support, and use of rear supports is highly recommended in all mobile and touring sound systems.

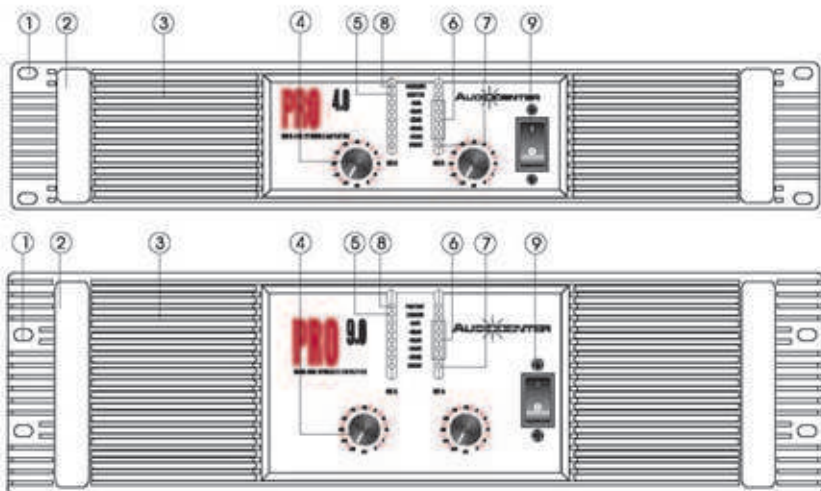

Never try to hold the circuit breaker/power switch in the "ON" position if it won't stay there itself!

1. Rack Mounting Ears.

Two front panel mounting holes are provided on each mounting ear.

2. Rack Handles.**3. Air cooling windows**

This part is the air cooling window. Don't obstruct it.

4. Input Attenuators.

Attenuators allow for precise setting of input gain.

5. Limiter LED.

Illuminates when amplifier limiter enters into action, preventing clipped output. Continuous illumination is not recommended.

6. Signal LED.

Illuminates to indicate that a signal (above a minimum threshold) is present at the amplifier input, and that the signal is being amplified.

7. Ready LED.

Indicates that AC power is connected and the amplifier is turned on. The light is white.

8. Protect LED.

Indicates that the channel is in Protect mode (speakers disconnected by output relay). The light is red.

9. AC Power Switch/Circuit Breaker.

PRO Series amplifiers have a front-panel combination AC switch and circuit breaker. (No fuses are used.) If the switch shuts off during normal use, push it back to the "ON" position once. If it will not stay on, the amplifier needs servicing.

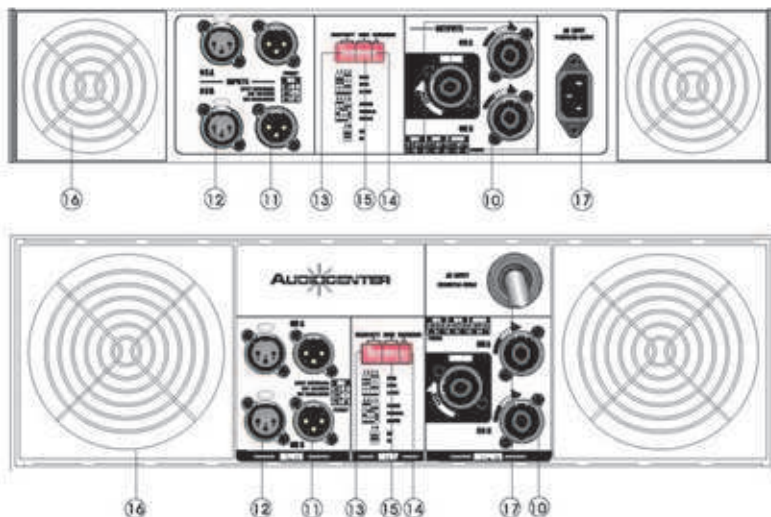

10. Output Connectors

Using speakon-type speaker cables, make connections to both the channel A and channel B connectors for stereo or parallel mode, or to the bridged mode connector for bridged mono mode, see the section on mode selection for more information.

11-12. XLR Input Connectors

These connectors accept input signals on balanced male and female XLR input plugs. Connectors for each channel are in parallel; the unused connectors may be used for "loop Through" Connection to other amplifiers.

13. Input sensitivity selector

This selector allows to choose the input sensitivity.

14. Mode Selection Switch

This DIP switch configures the Amplifier for Stereo, Parallel or Bridged Mono Mode operation. Amplifiers are factory-configured for stereo Mode.

15. Grounding selector

You may have hum or noise in your speaker, put the selector in "ON" position

16. Fan Outlet Grills.

PRO Series amplifiers are cooled by two, rear-mounted fans. Cool air flows over the heat sinks and exhausts through the front grills. Make sure these outlets remain clean to allow unrestricted air flow.

17. Mains Cord

Operation

Connecting Power / Circuit Size Requirements.

PRO Series amplifier power requirements are rated at:

- a) "idle"
- b) 1/8th power ("typical" music conditions)
- c) 1/3rd power ("continuous" music conditions)
- d) maximum rated power (circuit breaker limited).

The maximum power current draw rating is limited only by the front panel circuit breaker. Consult the specification in the *Appendices* section for figures on the current that each amplifier will demand. Make sure the mains voltage is correct and is the same as that printed on the rear of the amplifier. Damage caused by connecting the amplifier to improper AC voltage is not covered by any warranty. Unless otherwise specified when ordered, **AUDIO CENTER** amplifiers shipped to customers are configured as follows:

North America	-	120V AC/60Hz
Europe	-	230V AC/ 50Hz~60Hz
Asia	-	220V AC/ 50Hz~60Hz
Australia	-	240V AC/ 50Hz~60Hz
South America	-	120V AC/60Hz or 220V AC/ 50Hz
Japan	-	100V AC/ 50Hz

NOTE: Always turn off and disconnect the amplifier from mains voltage before making audio connections. Also, as an extra precaution, have the attenuators turned down during power-up.

Cooling System and Requirements.

PRO Series amplifiers use a twin-tunnel forced-air cooling system to maintain a low, even operating Temperature. Drawn in by dual 45 cubic feet-per-minute (CFM) fans on the rear panel, air flows through the cooling fans of the channel heat sinks (dissipating power transistor heat), then exhausts through the front panel slots.

When the amplifier is turned on, the fans briefly "rev up," then slow to an Idle; this indicates that the temperature sensing circuits are operating normally. extreme thermal load, the fans will force a very Large volume of air through the heat sinks. If either heat sink surpasses the maximum allowed temperature, the sensing circuit will open the output relay, disconnecting the load from that channel . If the power transformer overheats, another sensing circuit opens both channel output relays until the transformer cools to a safe temperature.

IMPORTANT: To ensure optimum cooling, periodically clean the amplifier fan filters (removable without tools). Also make certain that there is enough space around the front of the amplifier to allow the cooling air to escape. If the amplifier is rack-mounted, do not use doors or covers on the front of the rack; the exhaust air must flow out without resistance. If the amplifiers are to be housed in racks with closed backs, allow at least one (1) standard rack space of opening in the front of the rack for every four amplifiers.

Connecting Inputs.

Use XLR input connectors on the rear to supply audio signals to your ~~AudioCenter~~ PRO Series amplifier. Both connectors accept balanced and unbalanced audio connections. The unused connector can be used to jumper the audio input to another amplifier input. For more information, see the sections on *Balanced XLR Input Connectors*, *Input XLR Polarity*, and *Input Sensitivity*.

Connecting Outputs.

Speakers are connected using Speakon connectors. For more information, see the *Output Connectors* and *Mode Selection* sections.

Mode Selection.

The DIP Mode Select switch (located on the rear panel) configures the amplifier for either Stereo, Parallel or Bridged Mono Mode. Amplifiers are factory-configured for Stereo Mode.

Stereo Mode.

In Stereo Mode, both channels operate independently, with their input attenuators controlling their respective levels. Signal at Channel A's input produces output at Channel A's output, while signal at Channel B's input produces output at Channel B's output. Recommended minimum nominal load impedance for stereo operation is 2 ohms per channel.

Parallel Mode.

When set to Parallel Mode, a signal applied to Channel A's input will be amplified and appear at outputs for both Channels A & B. Input on Channel A.

Bridged Mono Mode.

Bridged Mono Mode straps both amplifier channels together to make a very powerful, single-channel monaural amplifier. One channel "pushes" and the other "pulls" equally, doubling the power over that of either channel alone. signal is applied to the Channel A input only. Both attenuators are used to control signal level; in addition, both must be adjusted to the same setting.

NOTE: The channel B input connectors may be used to "loop thru" the channel A signal when in parallel or bridged mono mode.

Use extreme caution when operating the amplifier in Bridged Mono Mode. Never ground either side of the speaker cable when the amplifier is in Bridged Mono Mode; both sides are "hot." If an output patchpanel is used, all connections must be isolated from each other and from the panel. The recommended minimum nominal load impedance in the Bridged Mono Mode is 4ohms, which is the equivalent to driving both channels separately at 2 ohms. Driving bridged loads of less than the recommended minimums will activate the LRS circuitry, resulting in a loss of power, and may also lead to a thermal protect condition. See figures on pages 9 showing output connection information.*



Connecting amplifier outputs to oscilloscopes or other test equipment while the amplifier is in bridged mode may damage both the amplifier and test equipment!

**Stereo Mode Connections
(Speakon Output Connectors)**

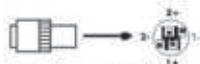

Speaker + to PIN 1+/2+
Speaker - to PIN 1-/2-

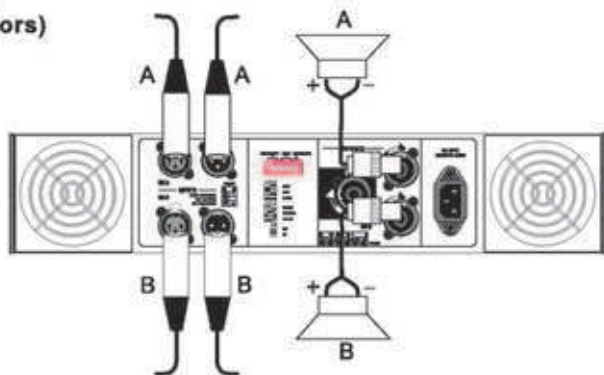

**Parallel Mode Connections
(Speakon Output Connectors)**



Speaker + to PIN 1+/2+
Speaker - to PIN 1-/2-

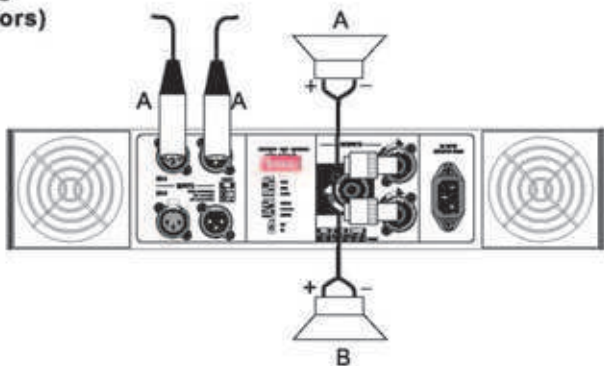

**Bridged Mono Mode Connections
(Speakon Output Connectors)**

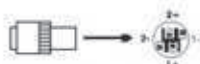

Speaker + to PIN 1+/2+
Speaker - to PIN 1-/2-

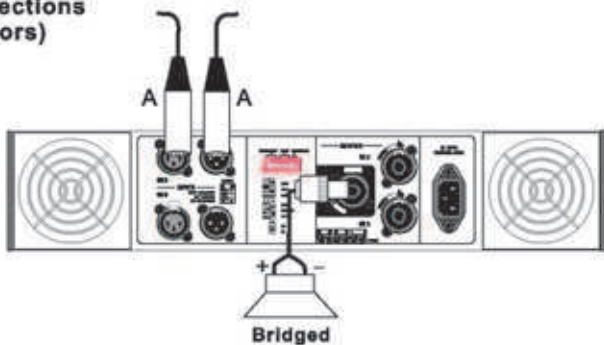

Protection Features

LX™ Clip Limiting Protection

At the amplifier's full power limit, or clipping point, LX™ will be activated. This is indicated by illumination of the Limiter LED. The channel gain is automatically reduced, protecting the loudspeakers from potential damage from the high power, continuous square waves that would otherwise be produced. LX™ may be activated by uncontrolled feedback, oscillations, improper equipment gain settings, or an equipment malfunction upstream from the amplifier. Only steady or excessive clipping (not normal program transients) will trigger LX™. The circuit is virtually transparent in operation and full signal bandwidth is maintained.

IGM Impedance Sensing.

IGM (Instantaneous Gain Modulation) is an innovative circuit that allows the amplifier to operate safely into difficult loads. When the amplifier sees a load that overstresses the output stage, the IGM circuit adjusts the channel gain to a safe level. Like LX™, the IGM circuit is inaudible in normal use. In addition, if extreme and sustained low impedance is encountered, the amplifier's output relay will open.

Auto Ramp Protection.

Auto Ramp operates every time the amplifier is turned on or is reactivated after a protect condition is corrected. Its exclusive **AUDIO CENTER** feature gradually increases gain to the attenuator setting avoiding unnecessary stress on the loudspeakers.

Thermal Protection.

Abnormally high heat sink temperatures will engage the Protect circuit for the overheating channel only. (An output relay disconnects the loudspeakers until nominal temperature range is restored.) During this time, the Protect LED will light. If the power transformer gets too hot, its thermal sensing circuit will disconnect both channel outputs. During this time, the Ready LED will extinguish, the Protect and Limiter LEDs will stay lit, and the cooling fan will continue running at low speed. Normal operation resumes once the transformer cools to a safe level.

LRS™ Short Circuit Protection.

If an output is shorted (i.e., defective speakers or crossed speaker wires) the LRS™ and thermal circuits will automatically protect the amplifier. The LRS™ circuit senses the short circuit as an extremely stressful load condition and attenuates the signal, protecting the channel's output transistors from over-current stress. If the short circuit remains, the load will be disconnected by the thermal protection circuitry (output relay Opens). And the amplifier will be locked. You need to remove the short circuit, shut down the amplifier and turn on again to restart the amplifier.

DC Voltage Protection.

If an amplifier channel detects DC voltage at its output terminals, the output relay will immediately open to prevent loudspeaker damage. The Protect LEDs will light.

Subsonic Frequencies.

Built-in high pass filtering provides subsonic frequency protection for each channel. In addition, a relay will open if excessive subsonic energy appears at the output.

User Precautions

Speaker Protection

All loudspeakers have electrical, thermal, and physical limits which must be observed to prevent damage or failure. Cone or compression drivers can be damaged (sometimes to the point of failure) from excessive power, low frequencies applied to high frequency drivers, severely clipped waveforms, and DC voltage. All PRO Series amplifiers automatically protect speakers from DC voltages and subsonic signals. For more information, see the TourClass Protection section.

Mid- and high-frequency transducers-compression driver in particular-are highly susceptible to damage from overpowering, clipped waveforms, or frequencies below their rated passband. When using an electronic crossover, make absolutely certain that the low and mid bands are connected to the correct amplifiers and drivers-and not accidentally connected to those for a higher or lower frequency band.

The amplifier's clipping point is its maximum peak output power. At maximum peak output power, **AUDIO CENTER** PRO Series amplifiers will deliver more power than many speakers can safely handle. Be sure the peak power capability of the amplifier is not excessive for your speaker system. To ensure that the speakers never receive excessive power, and to prevent amplifier clipping, use a properly adjusted external limiter (or a compressor with a ratio of 10:1 or higher) to control power output. Use one compressor/limiter for each frequency band in systems with active electronic crossovers.

The LX™ clip limiting circuit will automatically limit the duration of squared-off, continuous waveforms applied to the speakers. The amplifier will, however, allow normal musical transient bursts to pass. Of course, when the amplifier does clip, it is operating at its maximum output power. Note that some speaker systems are packaged with proprietary "processors" that have power limiting circuits and therefore should not require additional limiting.

Do not drive any low-frequency speaker enclosure with frequencies lower than its own tuned frequency. The reduced acoustical damping could cause a ported speaker to "bottom out" even at moderate power. Consult the speaker system specifications to determine its frequency limits, and employ a roll-off filter if necessary.

Recommended Speaker Cabling

The wire gauge charts will assist you in determining the optimum copper wire gauge for your speaker cables. Remember that the speaker cable resistance robs amplifier power in two ways: through power lost directly to resistance (often referred to as I^2R loss), and through increased total load resistance, which decreases the amount of power available from the amplifier. The charts (Appendix C) give cable length figures in feet/AWG wire gauges and in metric values.

Maintenance

A PRO Series amplifier requires no routine maintenance other than occasional cleaning or replacement of the fan intake filters on the rear of the amplifier. (This operation does not require any tools). Filters must be kept clean to ensure proper ventilation through the unit. If the amplifier is used in an extremely dusty or smoky environment, the filters should be cleaned or changed frequently and the unit should be periodically "blown free" (using compressed air) of any foreign matter that may penetrate through the filter.

Users will not need to make any internal adjustments to the amplifier during its lifetime. There are no user serviceable parts or adjustments that require opening the power amplifier. Cover removal exposes the risk of shock, so refer all servicing to qualified service technicians authorized by **AUDIO CENTER**.

User Responsibility

Your PRO Series amplifier is very powerful and can be potentially dangerous to loudspeakers and operators alike. It is your responsibility to read the section titled "Important Precautions" and make sure that the amplifier is installed, wired, and operated properly as instructed in this manual. Many loudspeakers can be easily damaged or destroyed by overpowering, especially with the high power available from a bridged amplifier. Read the section on Speaker Protection and always be aware of the speaker's continuous and peak power capabilities. **AUDIO CENTER** is not responsible for damage to loudspeakers for any reason.

Service and Repair

In the unlikely event that your amplifier develops a problem, it must be returned to an authorized distributor, service centre or shipped Directly to our factory. To obtain service, contact you nearest **AUDIO CENTER** Service centre, Distributor, Dealer, or any of the worldwide **AUDIO CENTER** offices. Because of the complexity of the design and the risk of electrical shock, all repair should be attempted only by qualified technical personnel. If the unit needs to be shipped back to the factory, it must be sent in its original carton. If improperly packed, your amplifier may be damaged.

For those with internet access, please visit the **AUDIO CENTER** website at: <http://www.ac-pro.net>



Appendices

Appendix A - Amplifier Specifications

Specifications		PRO4.0	PRO6.0	PRO7.0	PRO9.0	PRO12.0
Maximum Output Power	4Ω bridge	5600W	7700W	9800W	13650W	14000W
	8Ω bridge	4200W	6950W	7700W	10500W	12600W
	2Ω stereo	2×2800W	2×3850W	2×4900W	2×6825W	2×7000W
	4Ω stereo	2×2100W	2×2975W	2×3850W	2×5250W	2×6300W
Rated Power (20Hz-20KHz, <0.1%THD)	8Ω stereo	2×1400W	2×1960W	2×2450W	2×3500W	2×4200W
	4Ω bridge	1600W	2200W	2800W	3900W	4900W
	8Ω bridge	1200W	1700W	2200W	3000W	3800W
	2Ω stereo	2×800W	2×1100W	2×1400W	2×1960W	2×2000W
A-Guard Protection System	4Ω stereo	2×600W	2×850W	2×1100W	2×1500W	2×1800W
	8Ω stereo	2×400W	2×560W	2×700W	2×1000W	2×1200W
	DC protection			✓		
	Short circuit protection			✓		
	Smart overheat management			✓		
	Overheat protection			✓		
	Input overload protection			✓		
Output overload protection			✓			
Soft startup protection			✓			
Limiter protection				Up to 9V		
Frequency Response(1W 8Ω)		20Hz-20KHz(±0.5dB)				
Sensitivity		0.775V / 32dB / 26dB		0.775V / 36dB / 32dB		
Connectors	Input	Neutrik® male XLR&female XLR				
	Output	3xNeutrik® Speakon NLT 4MP				
Filter Capacitor Capacity		10000µf / 50V×8	10000µf / 63V×8	12000µf / 80V×8	15000µf / 100V×12	
Input Impedance	Balanced	20KΩ				
	Unbalanced	10KΩ				
Crosstalk(20Hz-20KHz, Rated power 8Ω)		≥85dB				
S/N Ratio (Rated power 8Ω, A weighted)		108dB				
Damping Factor(1KHz&8Ω)		≥500			≥850	
Intermodulation Distortion(20Hz-20KHz, half power)		≤0.05%				
Total Harmonic Distortion(20Hz-20KHz, half power)		≤0.05%				
Phase Response(1W&8Ω, 20Hz-20KHz)		20Hz+4° 20KHz-12°				
Slew Rate		≥45V/µs				
Output Circuitry		CLASS H+				
Power Consumption(Dual channel driven 4Ω, 1/8RMS/230V)		1.8A	2.4A	3.4A	4.6A	5A
Rack Space		2U			3U	
Cooling		Back to front venting, mandatory cooling				
Dimensions(W×H×D)		483×88×456mm			483×132×484mm	
Net Weight		18.0Kg	21.0Kg	22.5Kg	34.0Kg	36.0kg
Technical Support and After-sales Service		Global application support team				

Appendix B - PRO Block Diagram

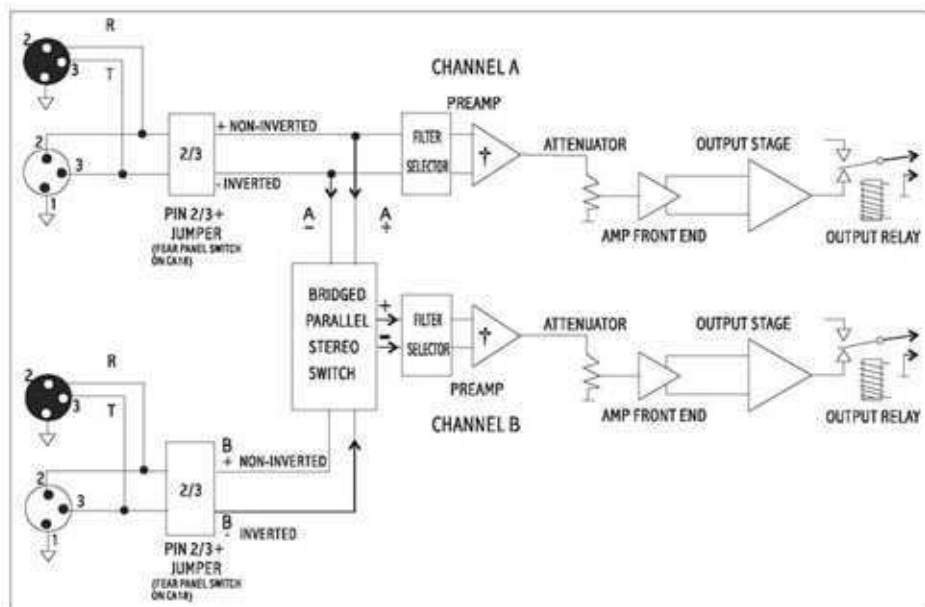

Appendix C - Wire Gauge Chart (Metric)

Stranded Cable Lgth. (m)	Wire Gauge (mm ²)	Power Loss	Power Loss	Power Loss
2	0.3	(8 ohm load)	(4 ohm load)	(2 ohm load)
	0.5	2.9%	5.6%	10.8%
	0.75	1.74	3.4	6.7
	1.5	1.16	2.3	4.5
	2.5	0.58	1.16	2.3
	4	0.35	0.70	1.39
5	0.5	0.22	0.44	0.87
	0.75	4.3%	8.2%	15.5%
	1.5	2.9	5.6	10.8
	2.5	1.45	2.9	5.6
	4	0.87	1.74	3.4
	6	0.55	1.09	2.2
10	0.5	0.37	0.73	1.45
	0.75	8.24%	15.5%	28%
	1.5	5.6	10.8	19.9
	2.5	2.9	5.6	10.8
	4	1.74	2.9	6.7
	6	1.09	1.74	4.3
30	0.75	0.73	1.09	2.9
	1.5	15.5%	0.73%	45%
	2.5	8.2	15.5	28
	4	5.1	9.8	18.2
	6	3.2	6.3	12.0
	10	2.2	4.3	8.2
		1.31	2.6	5.1

Stranded Cable Lgth. (ft.)	Wire Gauge (AWG)	Power Loss	Power Loss	Power Loss
5	18	(8 ohm load)	(4 ohm load)	(2 ohm load)
	16	0.81%	1.61%	3.2%
	14	0.51	1.02	2.0
	12	0.32	0.64	1.28
	10	0.20	0.40	0.80
10	18	0.128	0.25	0.51
	16	1.61%	3.2%	6.2%
	14	1.02	2.0	4.0
	12	0.64	1.28	2.5
	10	0.40	0.80	1.60
40	18	0.25	0.51	1.01
	16	6.2%	11.9%	22%
	14	4.0	7.7	14.6
	12	2.5	5.0	9.6
	10	1.60	3.2	6.2
	8	1.01	2.0	4.0
80	18	0.60	1.20	2.4
	16	11.9%	22%	37%
	14	7.7	14.6	26
	12	5.0	9.6	17.8
	10	3.2	6.2	11.8
	8	2.0	4.0	7.7
			1.20	2.4



AUDIOCENTER © Dynamic Audio Solutions